

2 - lags

Dato 19.11.2013	Tegn. M.B.Gilje	Godkjent T.Gilje	Revisjon 19.11.2014	Format 1 : 1	Ark nr.
Beskrivelse Gilje toppsving			Sammenstilling/Del Topp og bunn		Tegn. nr. 22GT56LLB562L--

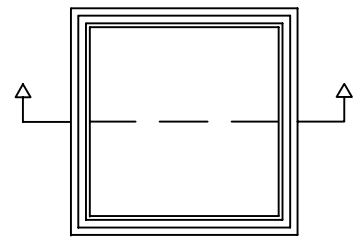

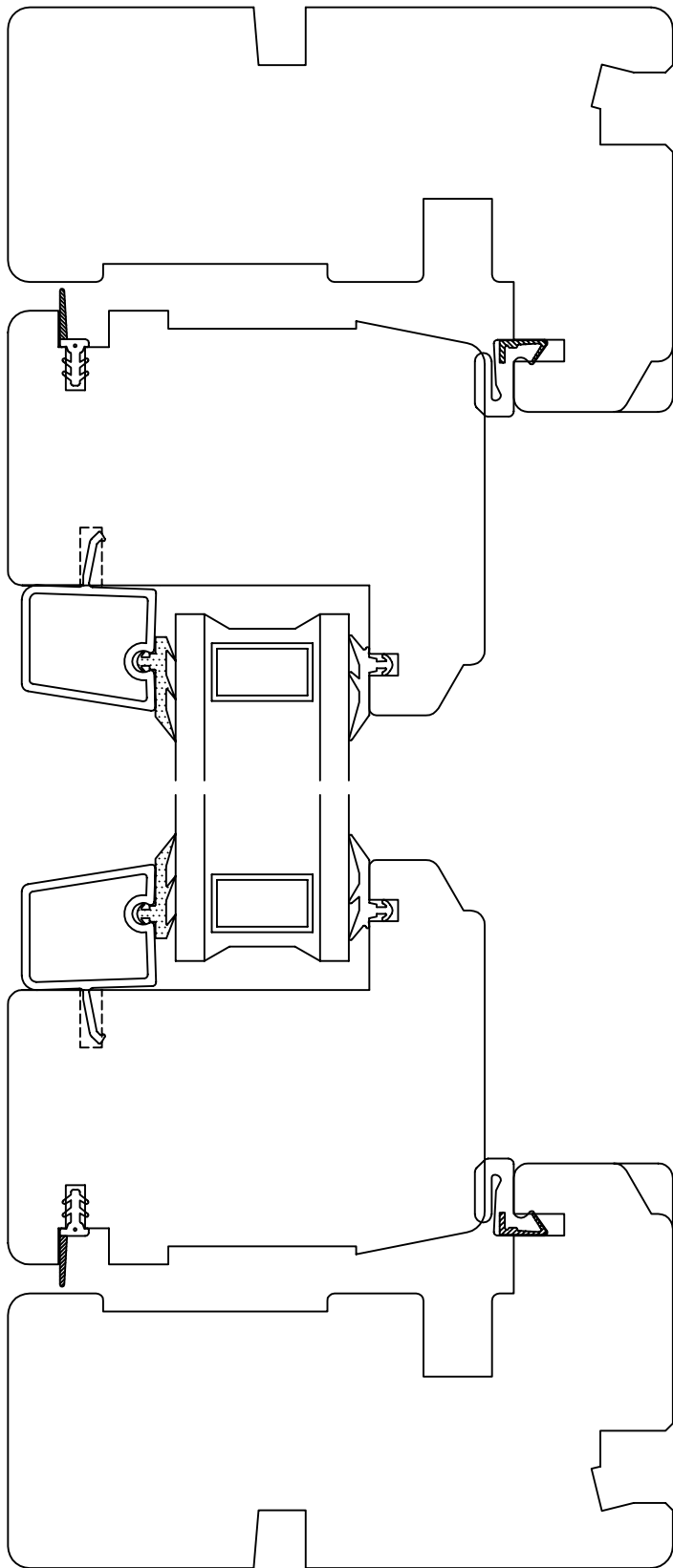

2 - lags

Dato 19.11.2013	Tegn. M.B.Gilje	Godkjent T.Gilje	Revisjon 19.11.2014	Format 1 : 1	Ark nr.
Beskrivelse Gilje toppsving			Sammenstilling/Del sider	Tegn. nr. 22GS56LLS562L--	



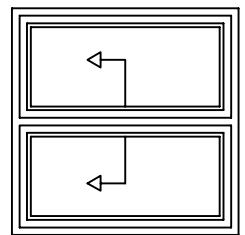
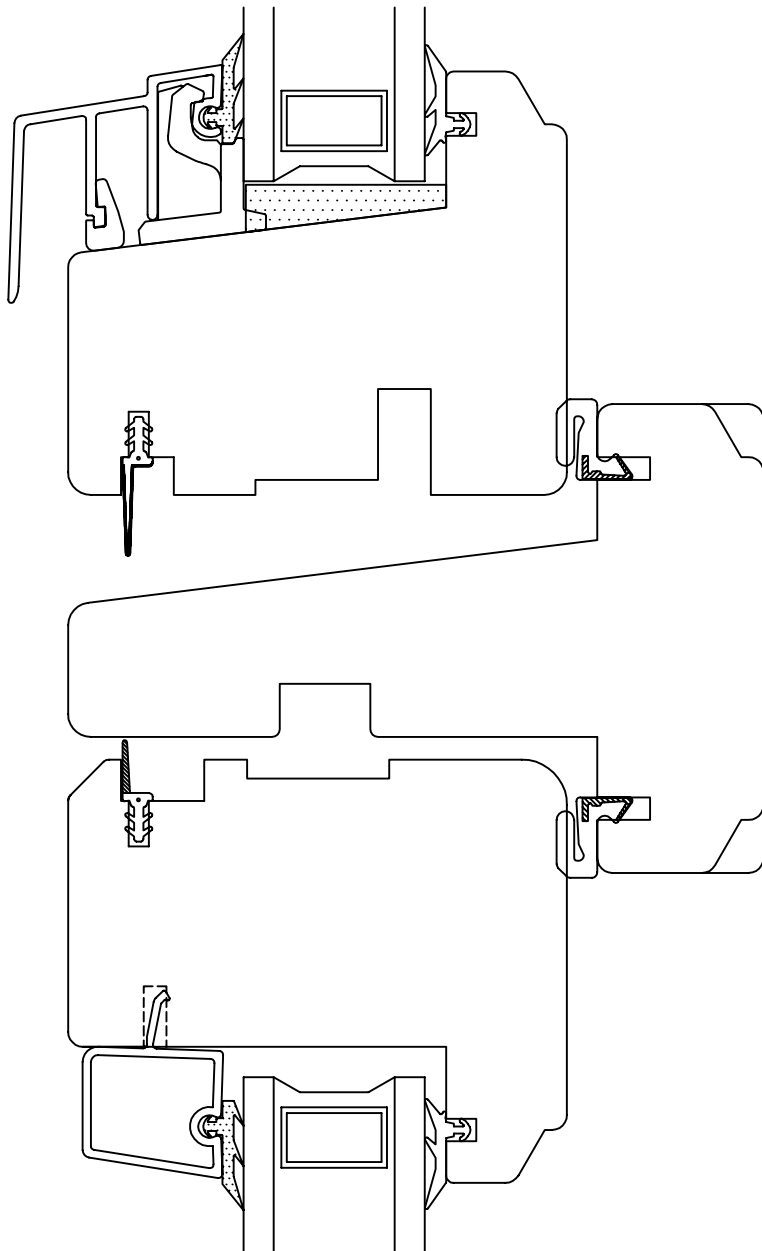

2 - lags

Dato 19.11.2013	Tegn. M.B.Gilje	Godkjent T.Gilje	Revisjon 19.11.2014	Format 1 : 1	Ark nr.
Beskrivelse Gilje toppsving			Sammenstilling/Del 62 mm losholt	Tegn. nr. 22GL62LL--2L--	

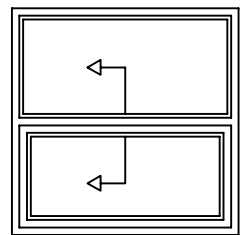
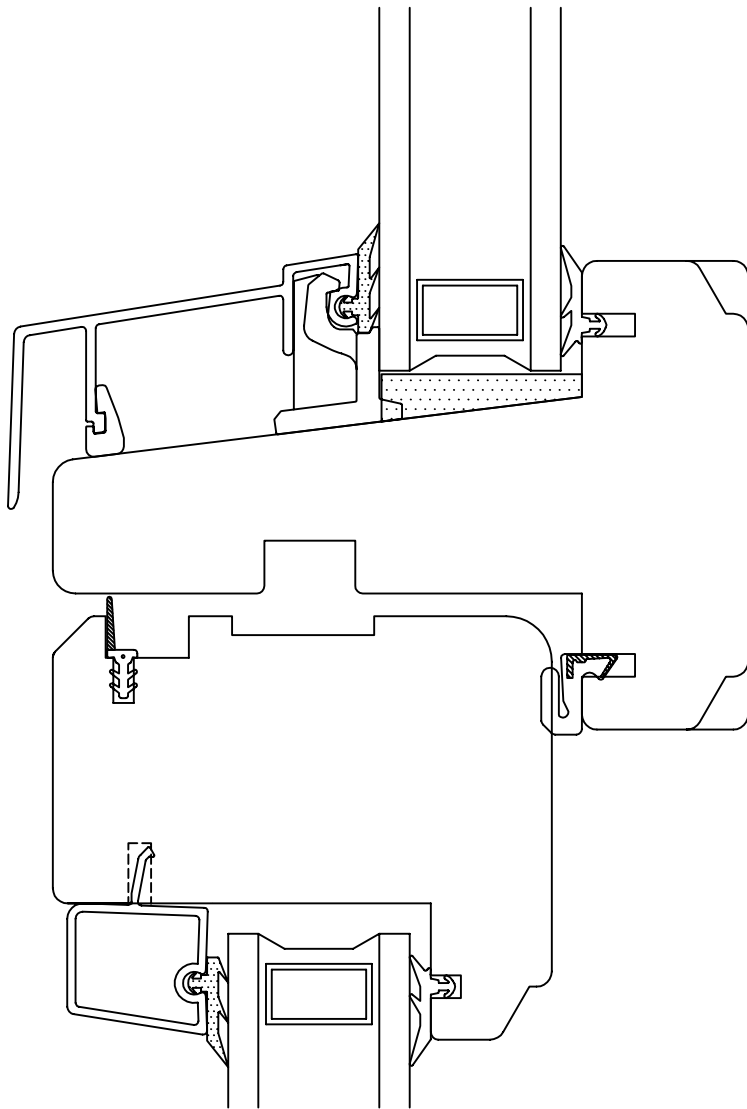

2 - lags

Dato 19.11.2013	Tegn. M.B.Gilje	Godkjent T.Gilje	Revisjon 19.11.2014	Format 1 : 1	Ark nr.
Beskrivelse Gilje toppsving			Sammenstilling/Del fast 62 mm losholt o.	Tegn. nr. 22GL62FL--2L--	

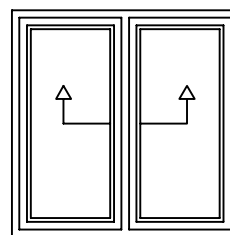
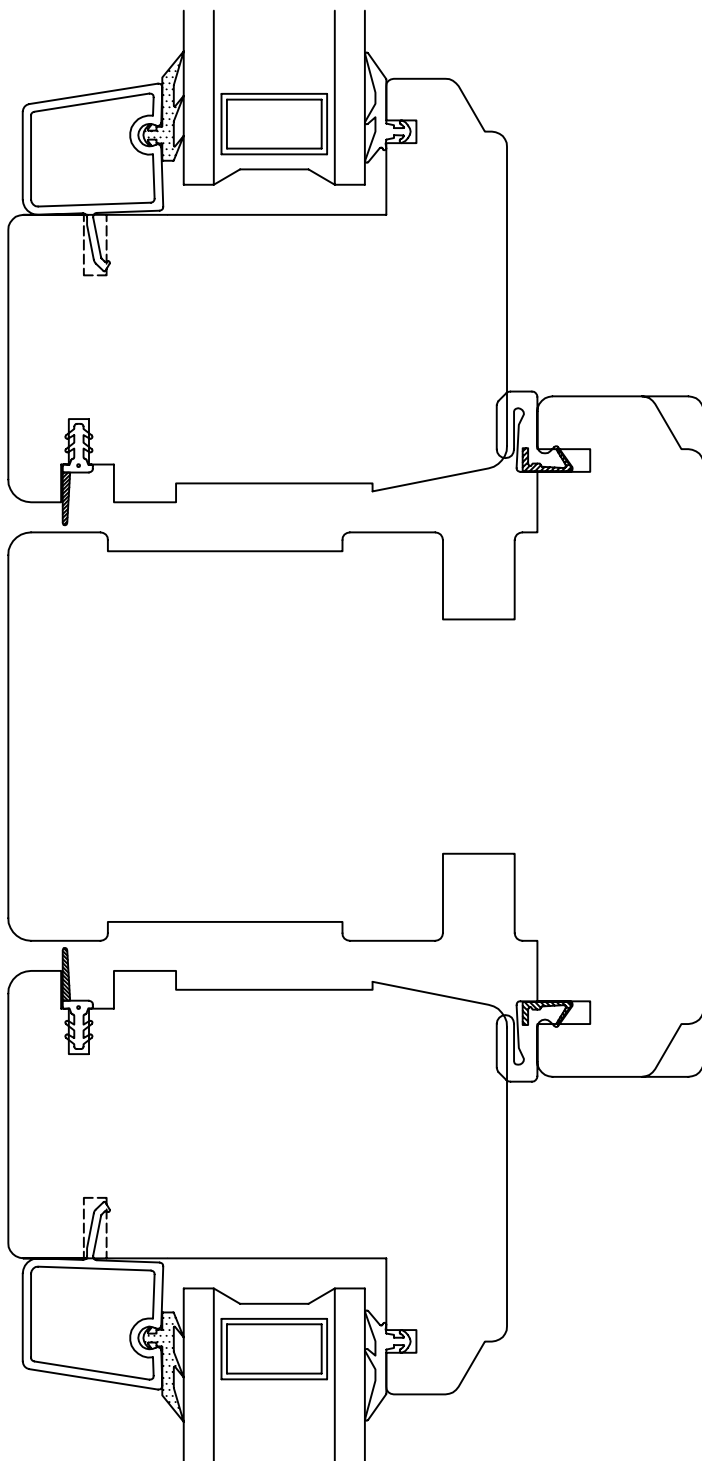

2 - lags

Dato 19.11.2013	Tegn. M.B.Gilje	Godkjent T.Gilje	Revisjon 19.11.2014	Format 1 : 1	Ark nr.	
Beskrivelse Gilje toppsving			Sammenstilling/Del 90 mm post		Tegn. nr. 22GP90LL--2L--	

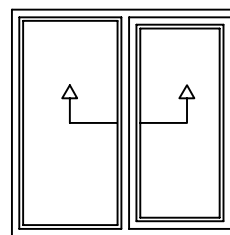
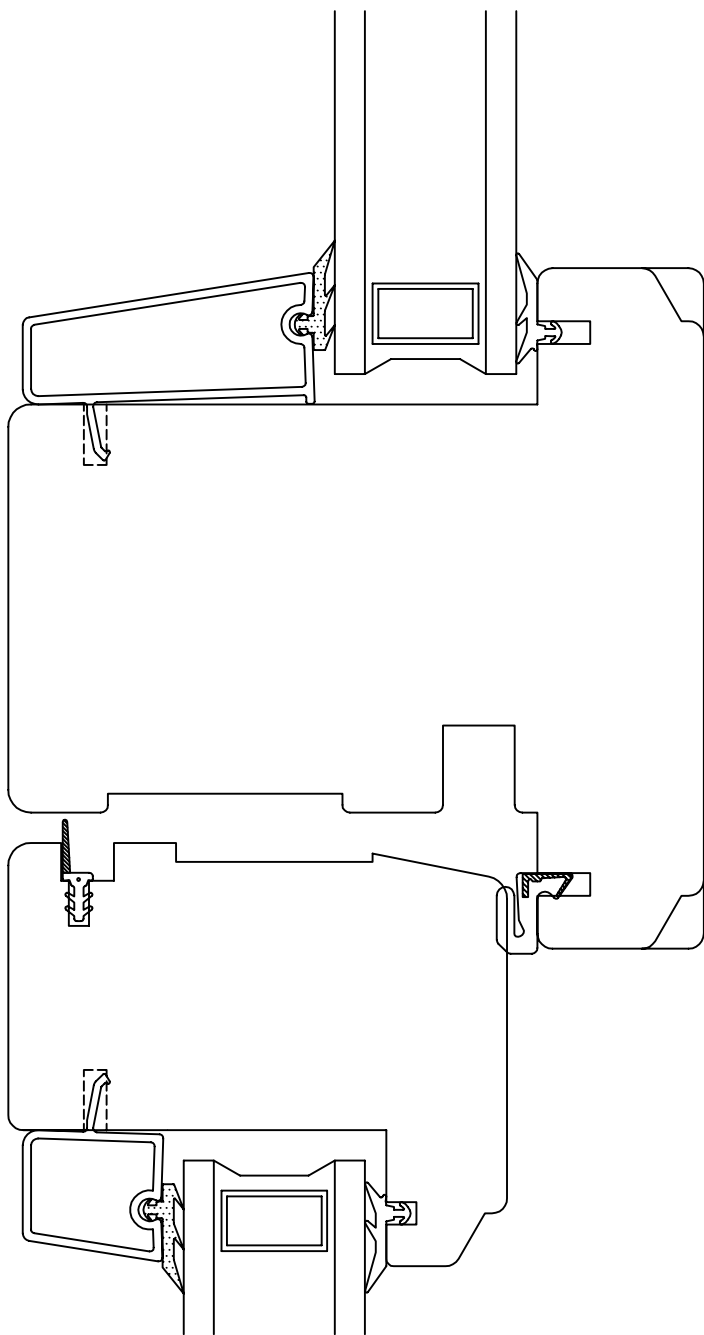

2 - lags

Dato 19.11.2013	Tegn. M.B.Gilje	Godkjent T.Gilje	Revisjon 19.11.2014	Format 1 : 1	Ark nr.	
Beskrivelse Gilje toppsving			Sammenstilling/Del 90 post , fast del en s.		Tegn. nr. 22GP90FL--2L--	