

Dato 03.12.2013	Tegn. M.B.Gilje	Godkjert T.Gilje	Revisjon 28.09.2015	Format 1 : 1	Ark nr.
Beskrivelse Gilje eXtra innadslående			Sammenstilling/Del topp bunn		Tegn. nr. 22JT48LLB483L--

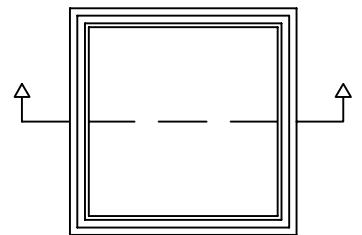

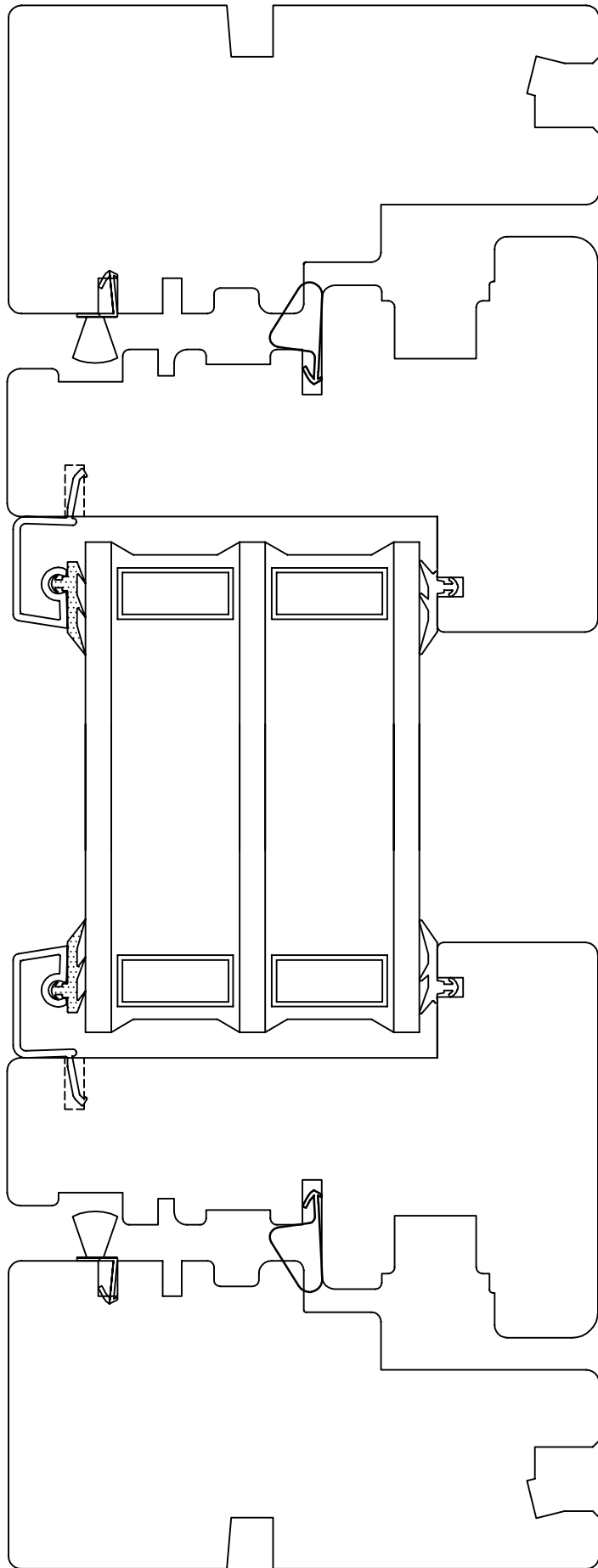

Dato 03.12.2013	Tegn. M.B.Gilje	Godkjert T.Gilje	Revisjon 28.09.2015	Format 1 : 1	Ark nr.
Beskrivelse Gilje eXtra innadslående			Sammenstilling/Del sider		Tegn. nr. 22JS48LLS483L--



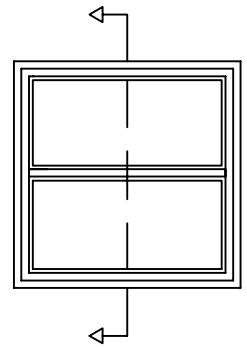
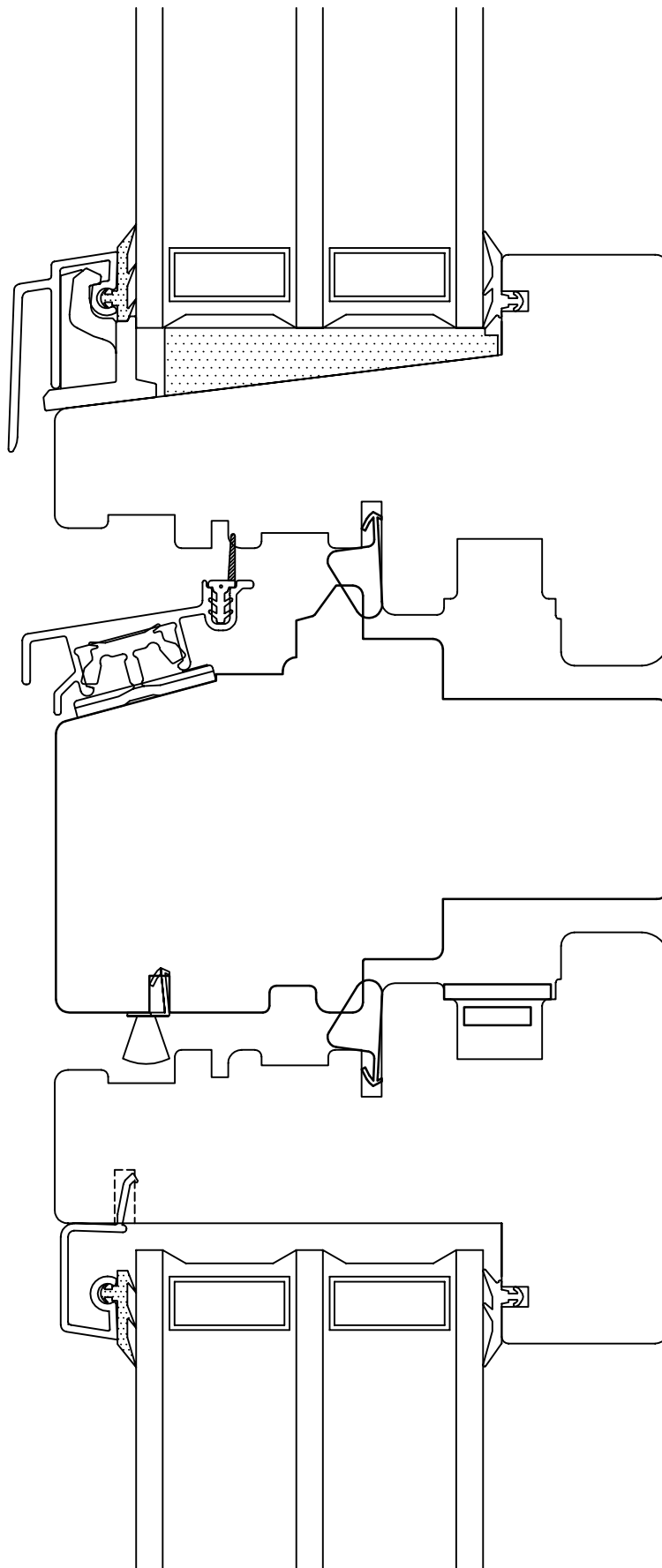

Dato 04.12.2013	Tegn. M.B.Gilje	Godkjert T.Gilje	Revisjon 28.09.2015	Format 1 : 1	Ark nr.
Beskrivelse Gilje eXtra innadslående			Sammenstilling/Del 64 mm losholt	Tegn. nr. 22JL64LL--3L--	



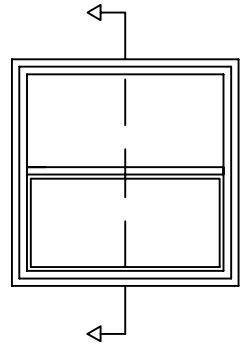
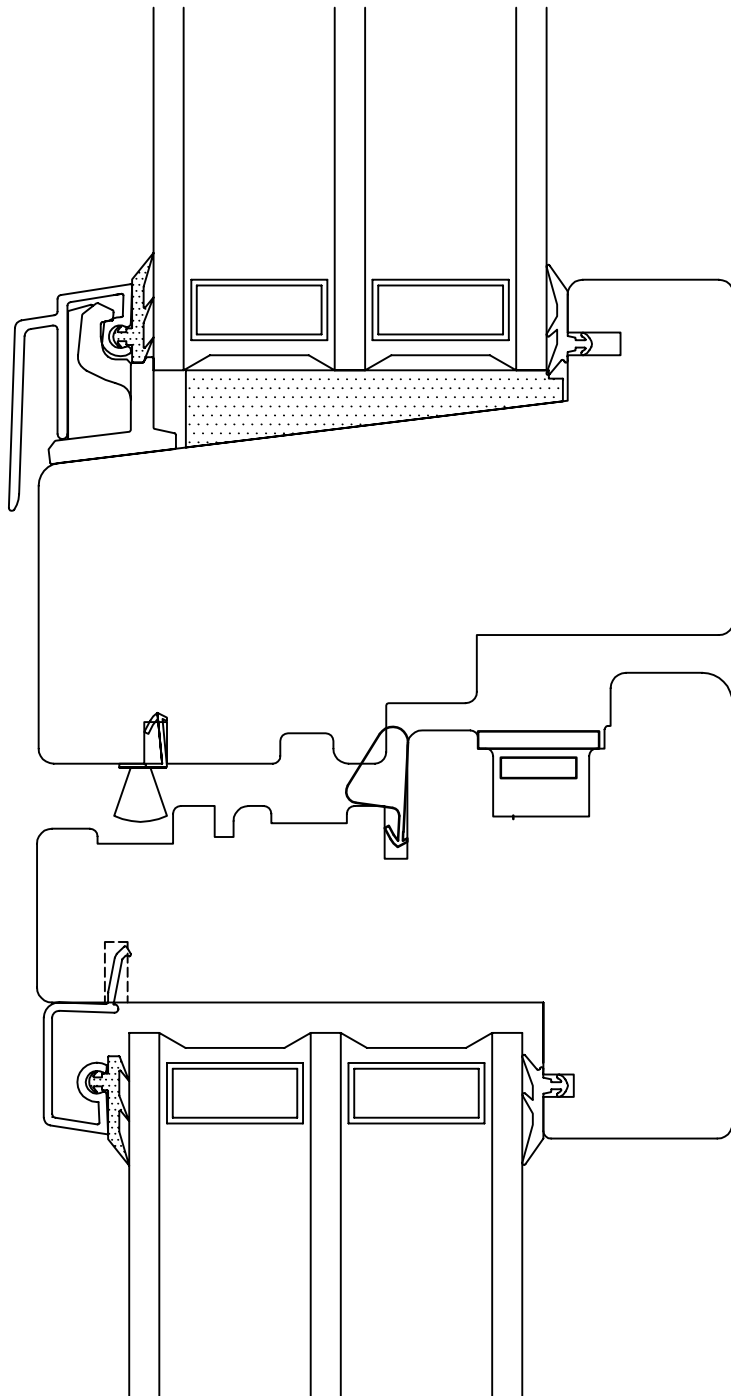

Dato 04.12.2013	Tegn. M.B.Gilje	Godkjert T.Gilje	Revisjon 28.09.2015	Format 1 : 1	Ark nr.
Beskrivelse Gilje eXtra innadslående			Sammenstilling/Del fast 64 losholt over	Tegn. nr. 22JL64FL--3L--	



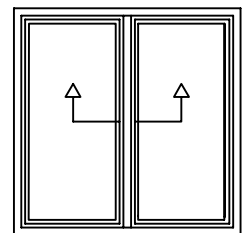
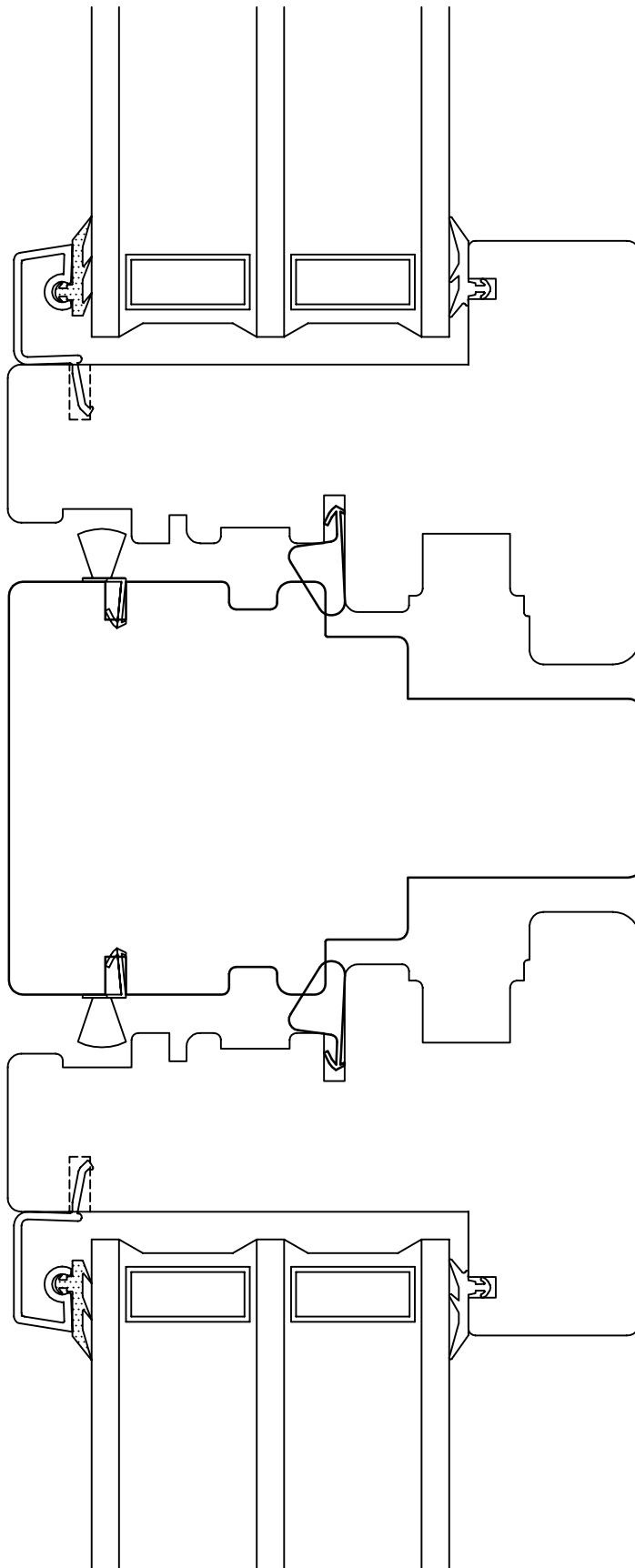

Dato 02.01.2014	Tegn. M.B.Gilje	Godkjert T.Gilje	Revisjon 28.09.2015	Format 1 : 1	Ark nr.	
Beskrivelse Gilje eXtra innadslående			Sammenstilling/Del 60 mm post		Tegn. nr. 22JP60LL--3L--	

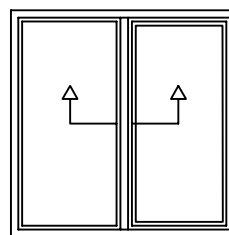
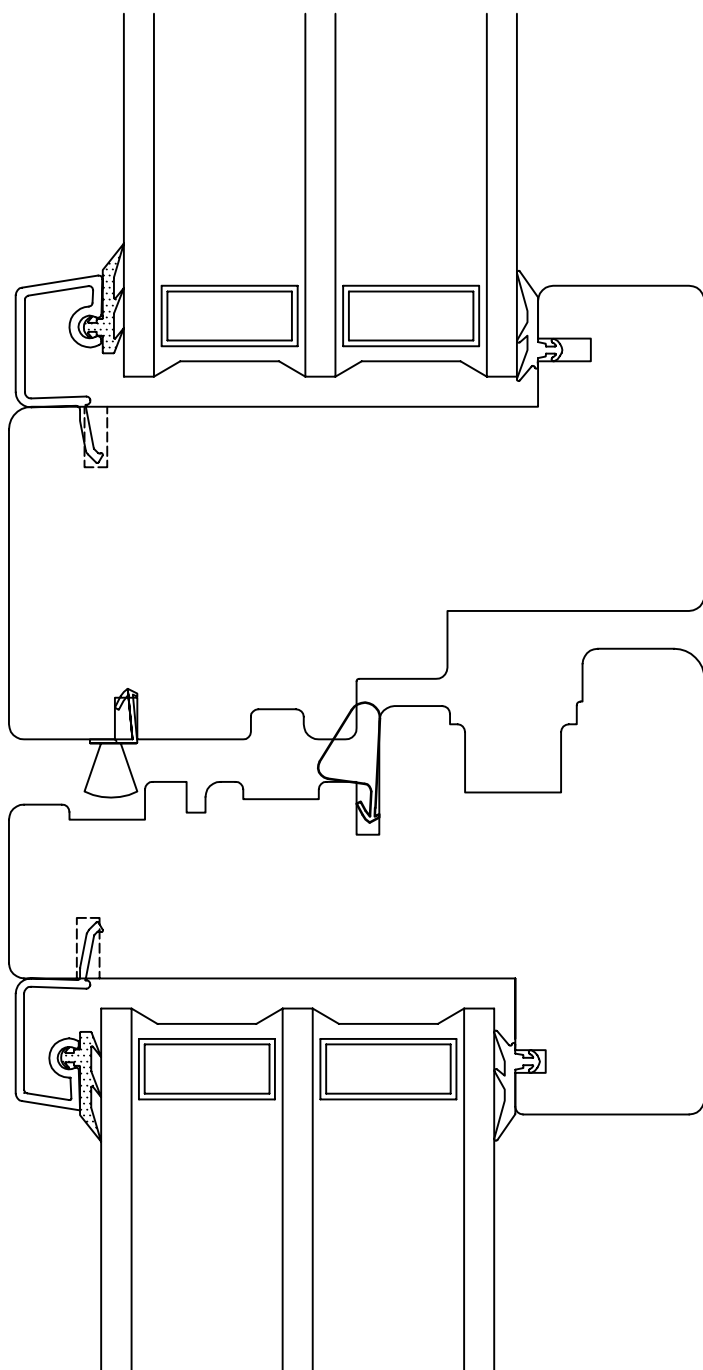

Dato 02.01.2014	Tegn. M.B.Gilje	Godkjert T.Gilje	Revisjon 28.09.2015	Format 1 : 1	Ark nr.
Beskrivelse Gilje eXtra innadslående			Sammenstilling/Del 60 post, fast del en s.	Tegn. nr. 22JP60FL--3L--	

